

HVLS APBG5S industrial 5-blade ceiling fan

COD:

SWHS000000000000



HVLS APBG5S industrial 5-Blade Ceiling Fan

- 5 Blades Extruded Aluminum Shaped Profile
- Narrow Cone Air Distribution
- Three-phase Brushless EC motor equipped with Integrated Electronic System and EMC filters 3
- Sizes with Diameters 4m / 5m / 6m
- Air Flow Rates up to 529,464 m³/h (AMCA230-99)
- 120 RPM Max
- Pot. Max Ass. 1.4 kW
- Suitable for continuous duty S1



Detailed description

HVLS stands for **HIGH FLOW LOW RPM** in Italian

These are large-scale industrial ceiling fans whose unique technical features can greatly improve summer comfort and winter energy savings. They can move huge air flow rates (up to 540,000 cu m/h) and do so at low RPM (maximum 110 RPM) . They represent an excellent alternative to coolers because they do not affect the ambient humidity level, while still creating a pleasant feeling in operators.

The APBG5S series is available in 3 sizes from 4,000mm to 6,000mm with air flow rates up to 430,000m³/h.

The complete fan is equipped with corresponding Blade Kit + Motor Kit.

CONSTRUCTION

Upper structure to protect the motor made of welded and painted steel.

The fan is equipped with:

- Safety cable set and tubular L = 800mm supplied.
- Blades made of aluminum EN AW 6063 T6.
- Aerodynamic blade terminals made of black plastic.
- Hub fitted with safety ring.
- Aesthetic hub cover made of black plastic.

FEATURES AND BENEFITS

- Narrow air distribution cone under the fan
- Absence of gears and aerodynamic design to ensure absolute quietness.
- Optimization of HVAC systems and reduction of CO₂ emissions, consumption and energy costs.
- Winter comfort achieved by bringing down the heat that stratifies at the top of the rooms, equalizing the temperature and avoiding further heating.
- Summer comfort achieved by keeping the air moving continuously, eliminating annoying hot-cold zones and creating a gentle breeze that promotes natural transpiration and drives away annoying insects.
- No routine maintenance required.
- Steel structure to ensure long life, strength and sturdiness.
- Several systems provided to ensure maximum safety (reinforced main safety cable, additional stabilization cables, hub safety ring).
- Aerodynamic blade terminals to optimize performance and acoustic comfort.
- Hub cover to protect against dust and for better design
- Simplified electrical connections.
- Integrated EMC filters to prevent possible electromagnetic interference with other devices.
- They operate at temperatures from 0°C to +50°C.
- Units are tested in accordance with the latest AMCA standards to ensure maximum reliability of performance data.
- Designed and manufactured according to the Machinery Directive (MD), Low Voltage Directive (LVD) and Electromagnetic Compatibility Directive (EMC).



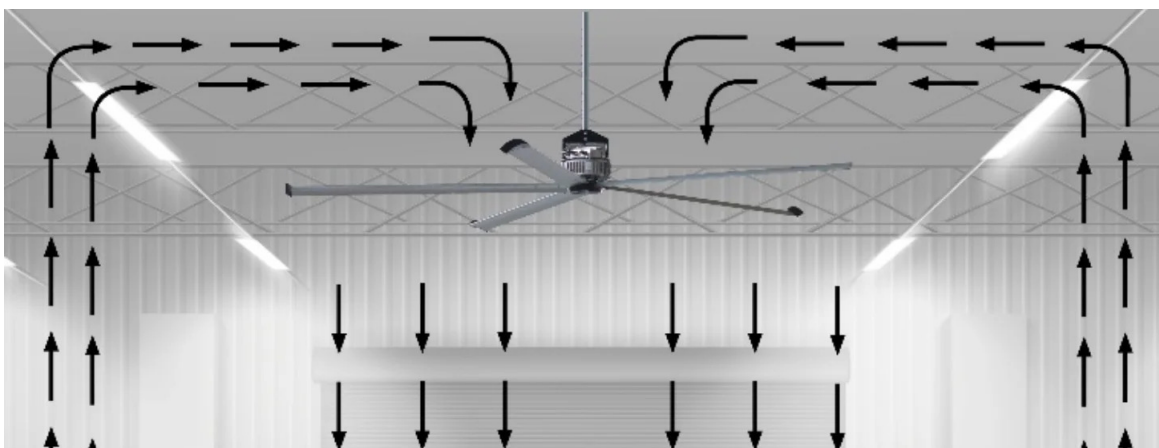
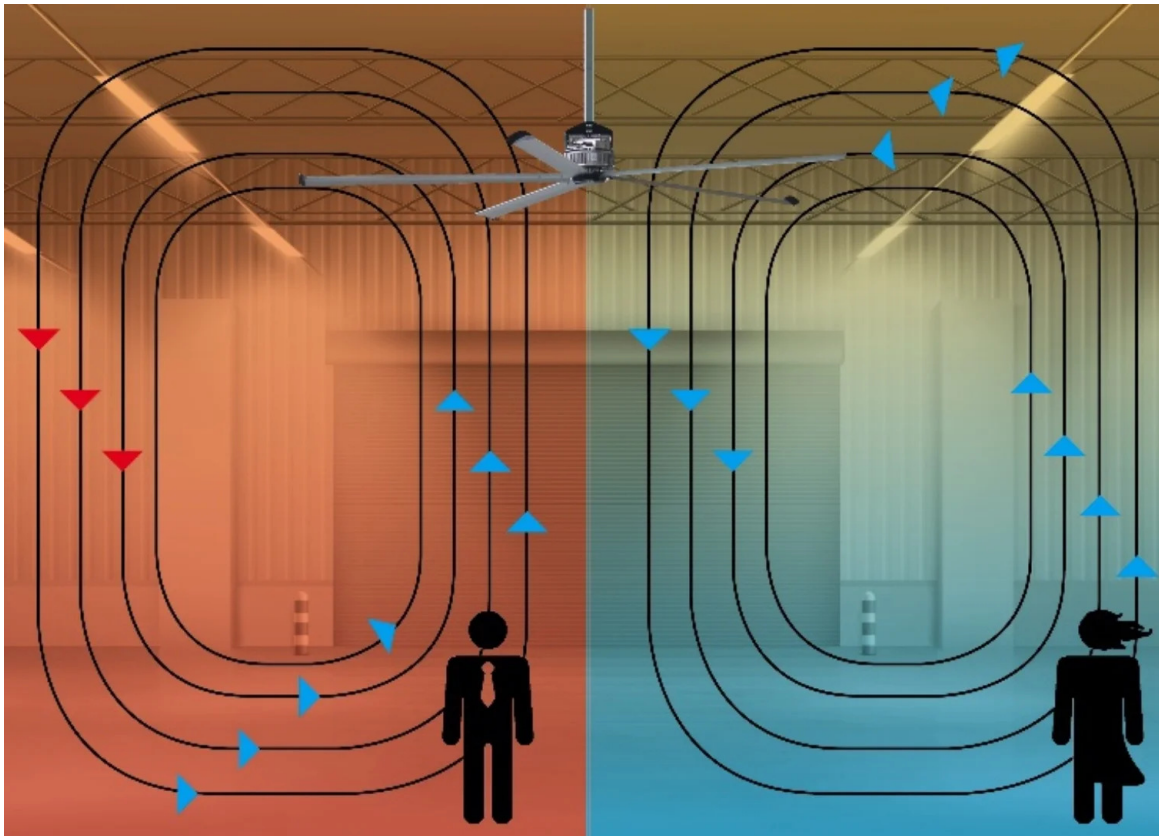
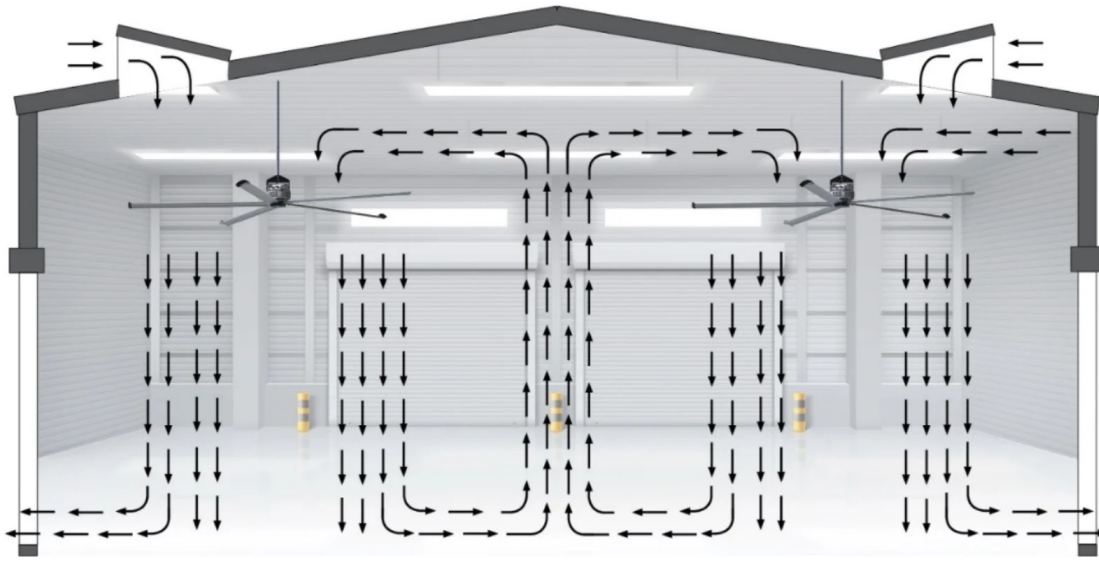

Dimensions

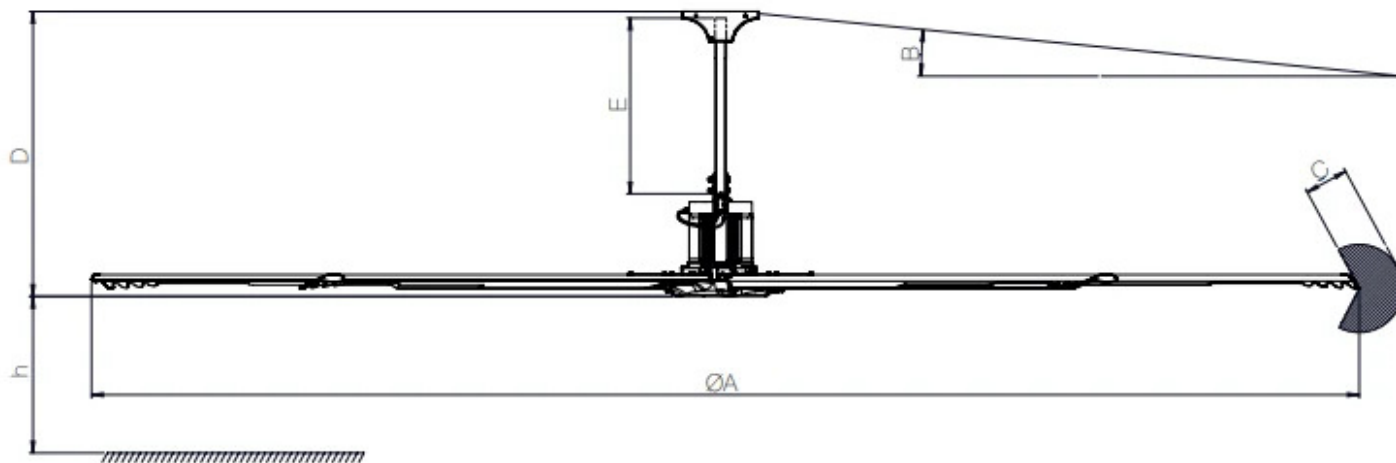

Code	A mm	B mm	C mm	D mm	E mm	h mm
SWHS40000000000	4000	20	450	1300	800	2700
SWHS50000000000	5000	20	550	1300	800	2700
SWHS60000000000	6000	20	650	1300	800	2700



Technical Data

Code	Power kW	Nominal flow rate m ³ / h	Weight kg	Power supply Hz	Motor	Rotational speed rpm
SWHS40000000000	0,8	271717	105	50/60	Three-phase	120
SWHS50000000000	1,1	365986	127	50/60	Three-phase	105
SWHS60000000000	1,4	429464	143	50/60	Three-phase	84



Photogallery

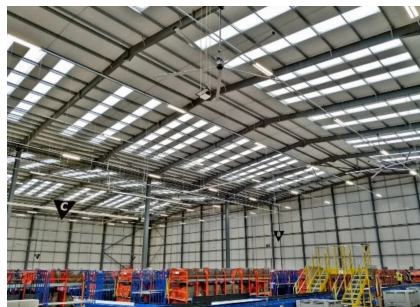
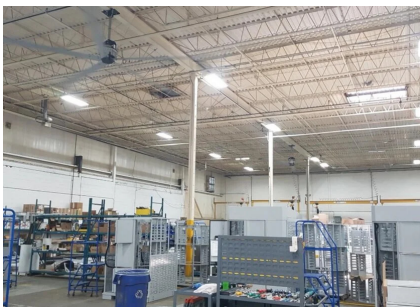
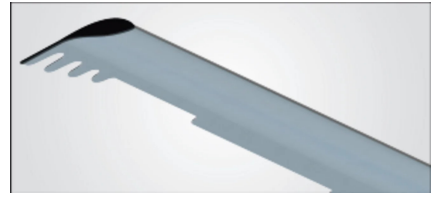
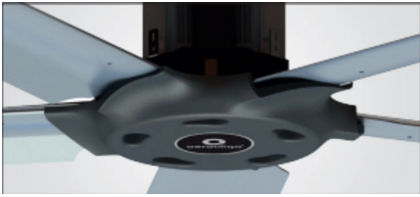

Accessories



3.5" touch control panel with color graphic display

PNLNCTR35000000

3.5" touch control panel with color graphic display that can control up to 4 units.



Potentiometer equipped with a bipolar ON/OFF switch

POTINTBIP000000

Remote potentiometer with front knob for manual adjustment of fan speed provided with two-pole switch (ON/OFF) and yellow front LED.



Control panel with anemometer and probe for temperature measurement

PNCANEMSND00000

Controller to control ventilation units according to the degree of temperature and wind speed.



Control panel with temperature probe included and humidity probe on request

PNCSNDUMID00000

Controller to control ventilation units according to temperature degree and THI level.

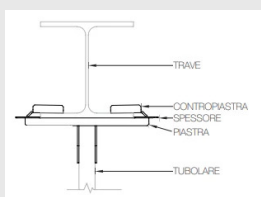

IPE/HEA/HEB beam fastening kit

KITIFEHEAHEB000

Fastening kit for SMHS fans in HVLS version compatible with most popular IPE, HEA, HEB steel profiles.



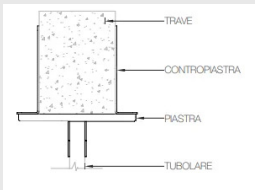

Fixing kit for rectangular section beams

KITRETTANGOL000

Fixing kit for SMHS fans in HVLS version compatible with rectangular section beams with base between 100mm and 260mm.



Related products



HVLS3 industrial 3-blade ceiling fan

SLHS000000000000

HVLS 3-Blade Industrial Ceiling Fans.

- 3 Blades Extruded in Anodized Aluminum against Corrosion with Constant Cross Section
- Precabled 3-phase Brushless EC motor equipped with Integrated Electronic System and EMC3 filters
- Sizes with Diameters 2.4m / 3m / 3.6m
- Air Flow Rates up to 134,271 m³/h (AMCA230-99)200
- Max RPM
- Pot. Max Ass. 0.7 kW
- Suitable for continuous duty S1.



HVLS APBG5 industrial 5-blade ceiling fan

SMHS000000000000

APBG5 5-Blade Industrial Ceiling Fan

- 5 Blades Extruded Aluminum Anodized Against Corrosion Constant Section
- Increased Air Distribution Cone
- Three-phase Brushless EC motor equipped with Integrated Electronic System and EMC filters
- 3 Sizes with Diameters 3.6m / 5.4m / 7.3m
- Air Flow Rates up to 438,818 m³/h (AMCA230-99)
- 110 RPM Max
- Pot. Max Ass. 0.75 kW

